

# EURONORM

## DRIVE SYSTEMS

### JI500 series



High-performance vector control inverter

## Euronorm

### **Vision**

Euronorm Drive Systems supplies the European machine building market and MRO market with electric motors variable frequency drives and transmissions to suit their applications and their target markets.

### **Mission Statement**

The mission of Euronorm is to provide its customers with such electric motors, variable frequency drives and transmissions so that they structurally contribute to their goals and (international) competitiveness. Reduction of (in)direct purchase costs (1), optimization of processes (2) and the creation of added value through innovative solutions (3) form the foundation of the success of their customers.

### **Company History**

Euronorm Drive Systems has more than 100 years history in the drive industry. Starting out as a manufacturer of belts, the company continues to develop in the field of electric motors, variable frequency drives and various types of transmissions such as gearboxes, geared motors, linear actuators and planetary gearboxes.

---

## Contents

Product overview .....	04
Technical features .....	05
Product performance .....	06
Main circuit terminal .....	12
Nameplate instruction .....	13
Technical specification .....	13
Standard specification .....	16
Keypad instruction .....	18
Installation instruction .....	19
Applications .....	20
Optional parts .....	22

## Product Overview

J1500 series high-performance vector control inverter type is based on the company's many years of design, production, sales, experience and it is suitable for all kinds of industrial machinery such as fan & water pump drive control, heavy industry such as medium frequency grinding and many more.

The J1500 is flexible, has a stable performance and is very reliable.



Oil



Chemical



Coal



Electric Power



Steel



Textile



Fan



Pump



Compressor



Injection



CNC



Winding



Crane



Conveyor



Heating



Solar Panel

## Technical Features

### Selflearning / Tuning

- Motor parameters can be measured during the self learning sequence. Both dynamic and static tuning is possible.

Rotary self learning	Static self learning
For the highest performance the motor must be able to run free, without any load during the autotuning.	When running free is not possible, a static autotune is also possible, but gives a less precise performance.

### Instantaneous power off don't stop function

- When grid instantaneous drops or peaks, the inverter can borrow feedback energy and keep running without stopping. This is especially suitable for equipment which needs higher continuity.

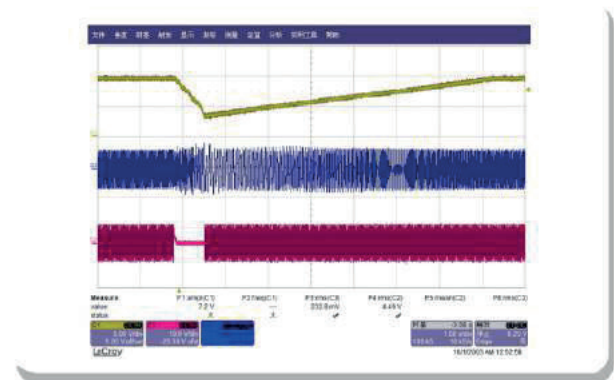

### Reliable design

- Meets the international standard of wide voltage input range. Rated voltage: 3phase 380-480v 50Hz/60Hz. Allow voltage float range: rated voltage  $\pm 15\%$ .

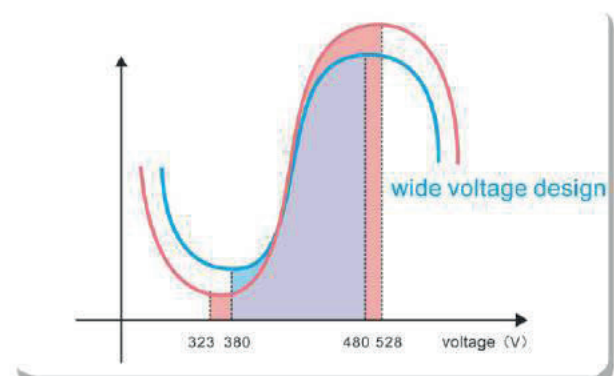

## Superior performance in motor drive

### Advanced motor drive technology

- A variety of motor drive technology: asynchronous motors or synchronous motors can be used on the JI500, due to the high-performance current vector control. Motors such as normal asynchronous motor, motor with encoder, asynchronous servo motor, permanent magnet synchronous motor, etc. can be used on the JI500.



### Steady speed precision, wide speed range

- **Open-loop vector control:**  
speed precision:  $\pm 0.5\%$   
adjustable speed range: 1: 100  
torque response:  $< 20\text{ms}$
- **Closed-loop vector control:**  
speed precision:  $\pm 0.02\%$   
adjustable speed range: 1: 1000  
torque response:  $< 5\text{ms}$
- **Load capacity**  
110%
- **Continuously**  
150% 1min  
180% 5s

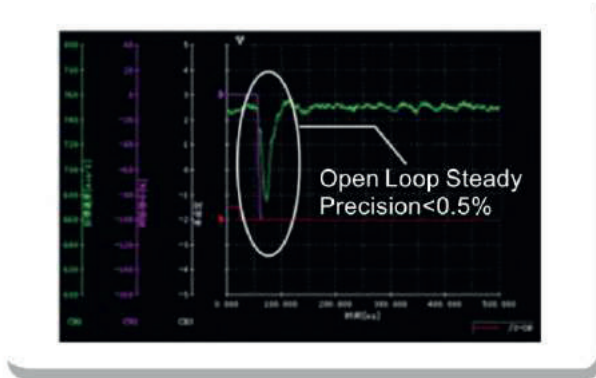

### Low speed with high torque small torque ripple

- In close-loop vector control, the torque linearity deviation is within 3%.

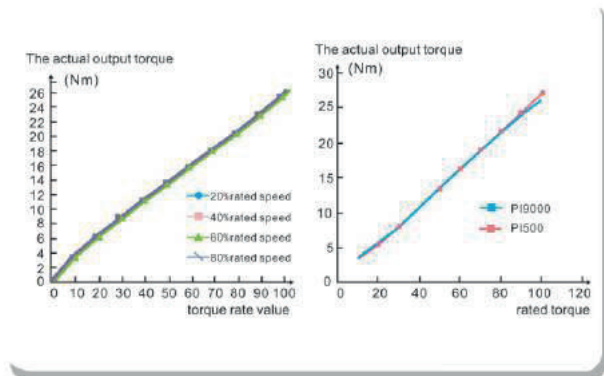

## Anti-corrosion paint spraying process

- High protection design, use of high quality anti-corrosion paint which is moisture proof, dustproof, oil proof. Corrosion resistancy improves the product reliability.

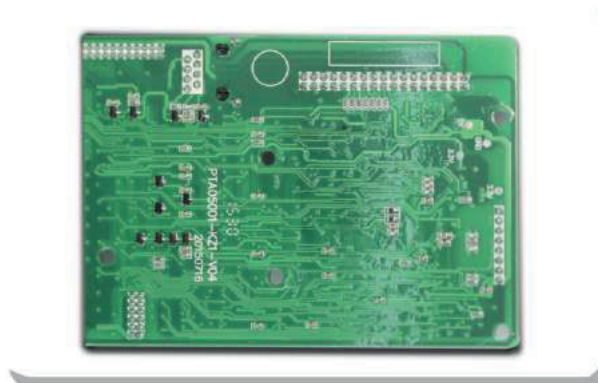

## Thermal reliability of the machine

- The JI500 series inverter is designed to have a very good thermal performance. Due to scientific simulations we have optimized the design in order to have the smallest possible housing with the maximum heat dissipating capacity.

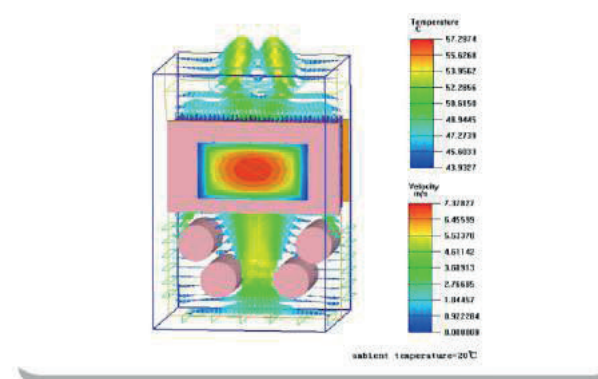

## Machine temperature rise test

- The full series of frequency converters have undertaken the rated load temperature rise test and overload temperature rise test.
- Each product has undertaken the a hours burn in test.



## EMC Design specifications Improved

- Optimized design for a minimum of noise.
- Standard built in C3 filter.
- Optional filters for C2 standard.

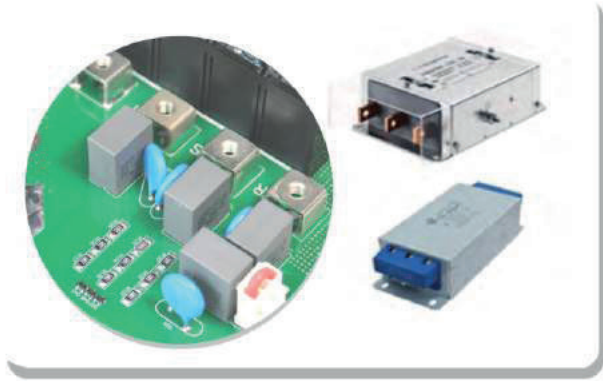

## Meets several of certification standards

- The products meet the requirements of EMC directive 2004/108/CE Electromagnetic compatibility directive and LVD directive, 2006/95/EC low voltage directive IEC61000-2-2:2002, IEC61000-4-2:2008, IEC61000-4-3:2008, IEC61800-5-1:2007, ROHS directive



## Independent air duct design

- Independent air duct design, the heat dissipating is better, it improves the reliability:
- High quality aircooling fans, with high capacity, supplies sufficient cooling and prevents dust contamination.

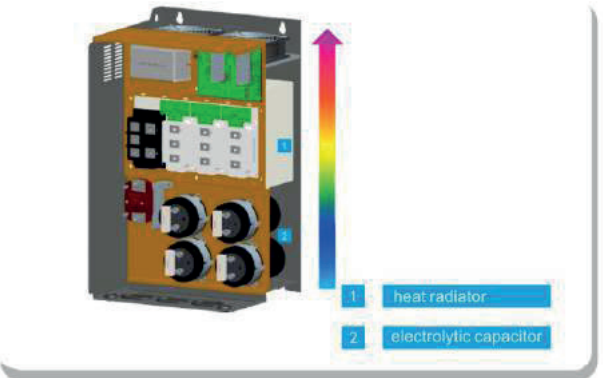



## Over-excitation function

- Fast braking and easy operating without any other periphery braking resistor, etc;
- Inhibit the increasing of DC-bus voltage while deceleration, avoid frequent errors when fast braking or fast stopping.

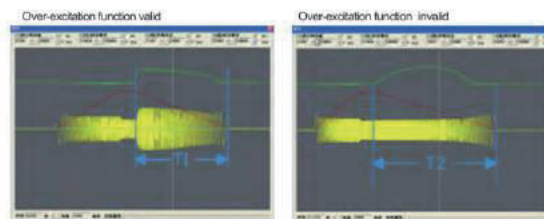

## Various kinds of terminals functions

- There are 51 kinds of multi-function terminals DI, 41 kinds of DO, 16 kinds of AO logical function choice;
- AI can be used as multi-function terminals DI freely;
- AI can be used in several ways, including PID functions;
- Groups of built-in analog DI and DO function choice, reduces external DI/DO cables, DI5 high-speed pulse input terminal and FM high-speed pulse output terminal supports a maximum of 100khz pulses.



## Long life design

- Use of first class manufacturers of rectifier bridge and IGBT, greater device selection, monitor all the temperature rises of key components and pcb board;
- Extended temperature rise range: it all contributes to a longer lifetime.
- Vibration test to make sure all components are vibration proof and well fixed;
- Sheet Metal design with galvanized parts and powder sprayed parts.

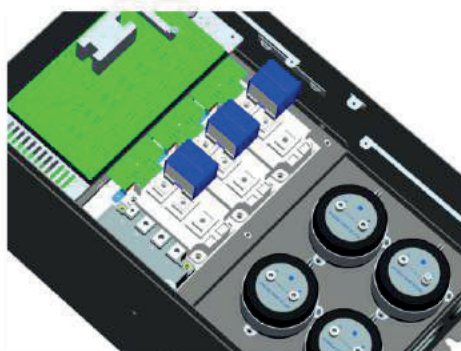

## Great environment friendly function

### New generation energy saving running

- Advanced energy control technology.
- Energy control technology to realize high efficient running of motor.
- Super energy saving while running with synchronous motor.
- ROHS approved, all components are environment friendly.

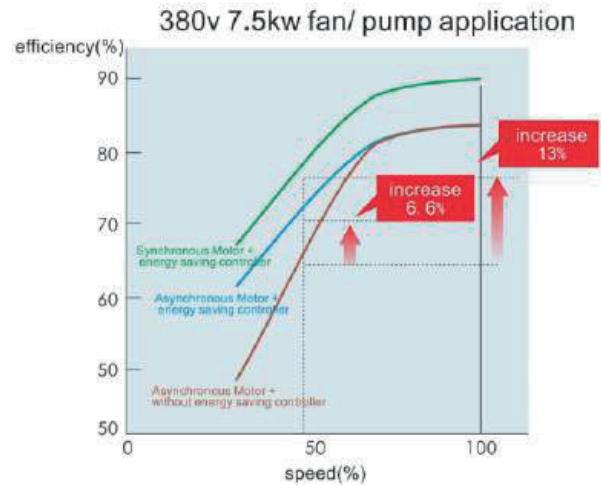

### Supporting various kinds of installation ways

- Wall-mounted, flange installation is available for 7.5-110kw (flange mounting needs peripheral accessories).
- Wall-mounted, flange installation, floor installation is available for 132-220kw (flange mounting, floor installation needs peripheral accessories);
- Wall-mounted, floor installation is available for 250-400kw (floor installation needs peripheral accessories); Floor-mounted is available for 450-630kw



### Simple maintenance

- Fan can be disassembled, is easy to install, to be cleaned and replaced.



## Built in self-adjusting PID function module

- Built in two groups of PID parameters, it is changeable according to the deviation, DI terminal and frequency;
- Various given and feedback source, variable and practical type
- PID feedback lost inspection function, it is convenient for the user to inspect the function;
- Setting factory parameters for special applications to meet the requirements, such as printing and packaging machine, drawing machine, etc. These applications are influenced by changing diameters. It simplifies the debugging process and makes it easy to implement the device.

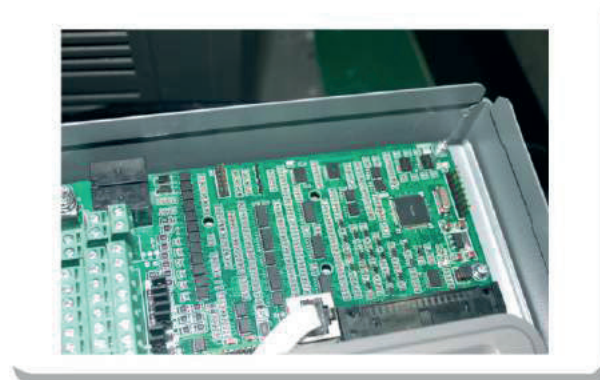

## Easy to use PC software

- Easy to use PC monitoring software enables tracking and fault location and with oscilloscope function, it's more convenient for clients to program and debug. Real time monitoring is also useful for analyzing and management.

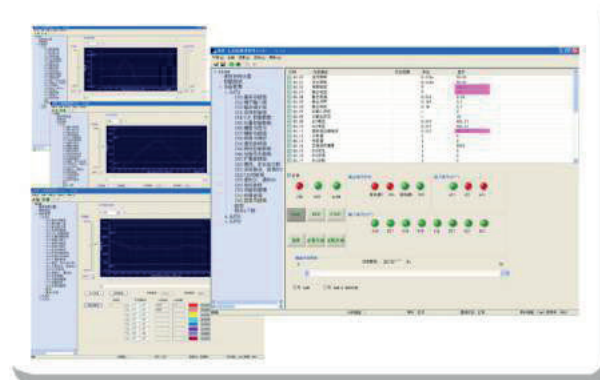

## Communication interface application is very flexible

- Supports Modbus RTU, CANopen, Profibus-DP Protocol;
- Through a dedicated distribution point of the inverter parameters, to realize a good multi-level load distribution, multi-machine control applications droop.



## Main circuit terminal

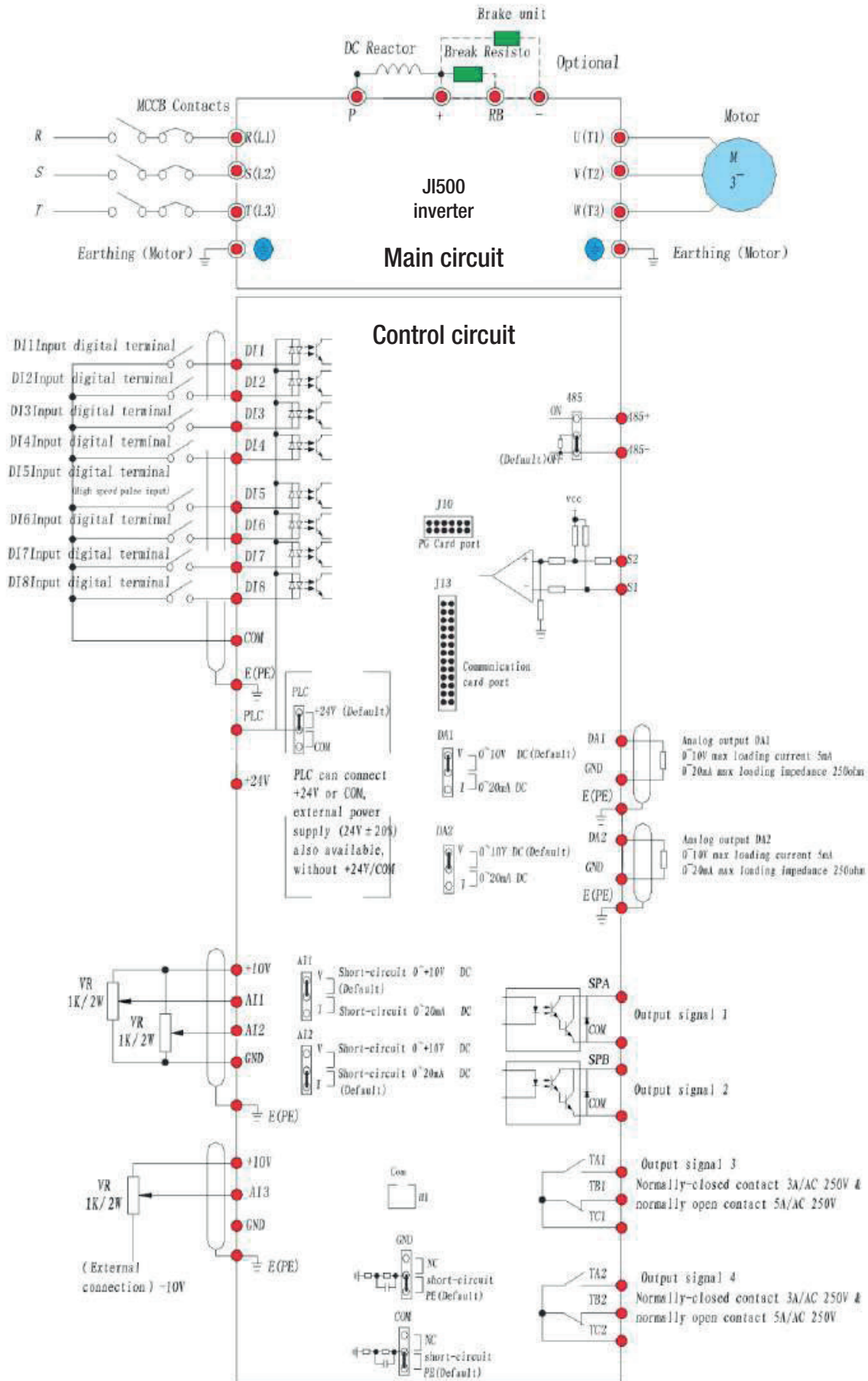

## Improve production efficiency!

### Nameplate instruction

Inverter model	→	<b>EURONORM</b> DRIVE SYSTEMS	CE
Output rating	→	MODEL: J1500 7R5G3	
Input rating	→	POWER: 7.5kW	
Output specifications	→	INPUT: AC 3PH 440V 20.5A 50Hz/60Hz	
Bar code	→	OUTPUT: AC 3PH 0~440V 17A 50Hz/60Hz	
Serial No.	→		
Manufacturer address	→	ZPB1A8888888	
		www.euronormdrives.nl	

### Technical specification

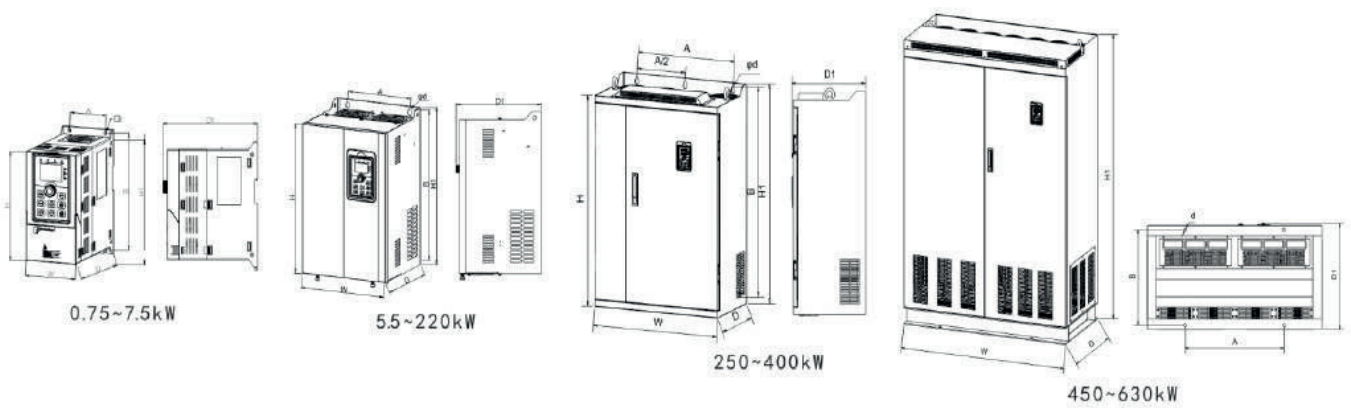

with DC choke

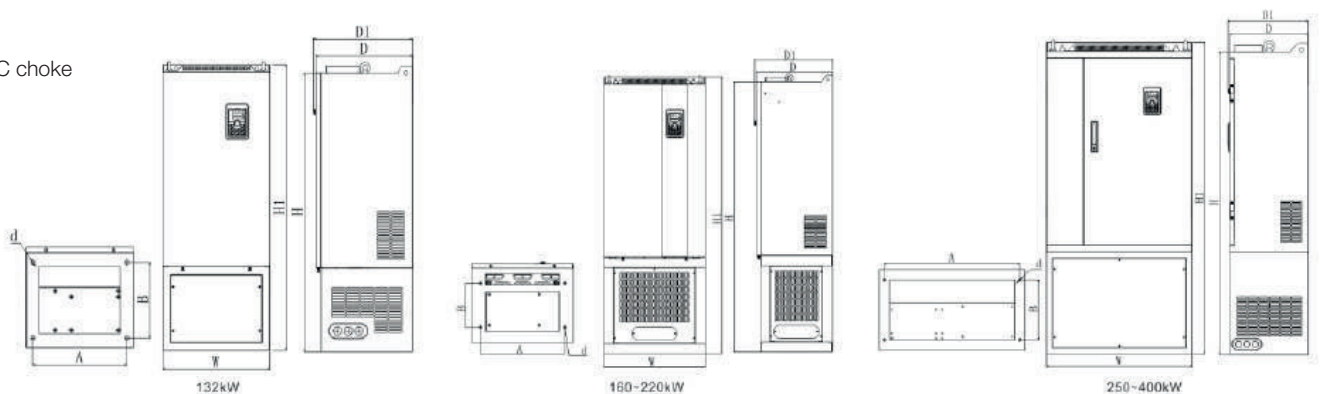

Inverter model	Output power (kW)	Input current (A)	Output current (A)	Dimension (H1xWxD1 mm)					Installation (AxB d mm)			N.W (KG)
				H	H1	W	D	D1	A	B	d	
JI500 5R5G1	5.5	50	25	280	300	190	190	198	140	285	6	7.2
JI500 7R5G1	7.5	74	32	330	350	210	190	198	150	335	6	9.5
JI500 011G1	11	84	45									
JI500 015G1	15	115	60	380	400	240	215	223	180	385	7	13
JI500 018G1	18.5	144	75									
JI500 022G1	22	169	90	500	520	300	275	283	220	500	10	41.2
JI500 030G1	30	220	110									
JI500 037G1	37	276	152									
JI500 045G1	45	325	176	550	575	355	320	328	250	555	10	58
JI500 055G1	55	380	210									
JI500 5R5G2	5.5	28	25									
JI500 7R5G2	7.5	37.1	32	330	350	210	190	198	150	335	6	9.5
JI500 011G2	11	49.8	45									
JI500 015G2	15	65.4	60	380	400	240	215	223	180	385	7	13
JI500 018G2	18.5	81.6	75									
JI500 022G2	22	97.7	90	500	520	300	275	283	220	500	10	41.2
JI500 030G2	30	122.1	110									
JI500 037G2	37	157.4	152									
JI500 045G2	45	185.3	176	550	575	355	320	328	250	555	10	58
JI500 055G2	55	214	210									
* JI500 OR7G3	0.75	4.3	2.5	163	185	90	146	154	65	174	5	1.9
* JI500 1R5G3	1.5	5	3.8									
* JI500 2R2G3	2.2	5.8	5.1									
* JI500 004G3	4	10.5	9	163	185	90	166	174	65	174	5	1.9
* JI500 5R5G3	5.5	14.6	13	238	260	120	180	188	90	248	5	2.6
* JI500 7R5G3	7.5	20.5	17									
JI500 7R5G3/011F3	7.5/11	20.5/26	17/25	280	300	190	190	198	140	285	6	7.2
JI500 011G3/015F3	11/15	26/35	25/32									
JI500 015G3/018F3	15/18.5	35/38.5	32/37									
JI500 018G3/022F3	18.5/22	38.5/46.5	37/45	330	350	210	190	198	150	335	6	9.5
JI500 022G3/030F3	22/30	46.5/62	45/60									
JI500 030G3/037F3	30/37	62/76	60/75	380	400	240	215	223	180	385	7	13
JI500 037G3/045F3	37/45	76/91	75/90									

Note: JI500G3 with \* series 0.75kW - 7.5kW have a plastic housing (others are sheet metal), 0.75kW - 4kW with DIN-rail mounting

Inverter model	Output power (kW)	Input current (A)	Output current (A)	Dimension (H1xWxD1 mm)					Installation (AxB d mm)			N.W (KG)
				H	H1	W	D	D1	A	B	d	
JI500 045G3/055F3	45/55	91/112	90/110	500	520	300	275	283	220	500	10	41.2
JI500 055G3	55	112	110									
JI500 075F3	75	157	150									
JI500 075G3	75	157	150									
JI500 093F3	93	180	176	550	575	355	320	328	250	555	10	58
JI500 93G3/110F3	93/110	180/214	176/210									
JI500 110G3/132F3	110/132	214/256	210/253									
JI500 132G3/160F3	132/160	256/307	253/304	695	720	400	360	368	300	700	10	72.5
JI500 160G3/187F3	160/187	307/345	304/340	790	820	480	360	368	370	800	11	108
JI500 187G3/200F3	187/200	345/385	340/380									
JI500 200G3/220F3	200/220	385/430	380/426									
JI500 220G3	220	430	426									
JI500 250F3	250	468	465	940	980	705	380	388	550	945	13	190
JI500 250G3/280F3	250/280	468/525	465/520									
JI500 280G3/315F3	280/315	525/590	520/585									
JI500 315G3/355F3	315/355	590/665	585/650									
JI500 355G3/400F3	355/400	665/785	650/725									
JI500 400G3	400	785	725									
JI500 132G3R/160F3R	132/160	883	820	995	1020	400	360	368	350	270	13*18	114.5
JI500 160G3R/187F3R	160/187	883/920	820/860	1230	1260	480	360	368	400	200	13	153
JI500 187G3R/200F3R	187/200	920/1010	860/950									
JI500 220G3R/200F3R	200/220	1010/1160	950/1100									
JI500 220G3R	220	1160/1310	1100/1250									
JI500 250F3R	250	256/307	253/304	1419	1460	705	380	388	620	240	13	249.4
JI500 250G3R/280F3R	250/280	307/345	304/340									
JI500 280G3R/315F3R	280/315	345/385	340/380									
JI500 315G3R/355F3R	315/355	385/430	380/426									
JI500 355G3R/400F3R	355/400	430	426									
JI500 400G3R	400	468	465									
JI500 450G3R	450	468/525	465/520	/	1700	1200	600	612	680	550	17	-
JI500 450G3/500F3R	450/500	525/590	520/585									
JI500 500G3/560F3R	500/560	590/665	585/650									
JI500 560G3/630F3R	560/630	665/785	650/725									
JI500 630G3/700F3R	630/700	785	725									
JI500 7R5G4/JI500 011F4	7.5/11	18.2/23.1	15/22	280	300	190	190	198	140	285	6	7.2
JI500 011G4/JI500 015F4	11/15	23.1/29.8	22/27									
JI500 015G4/JI500 018F4	15/18.5	29.8/35.7	27/34									
JI500 018G4/JI500 022F4	18.5/22	35.7/41.7	34/40	330	350	210	190	198	150	335	6	9.5
JI500 022G4/JI500 030F4	22/30	41.7/57.4	40/55									
JI500 030G4/JI500 037F4	30/37	57.4/66.5	55/65	380	400	240	215	223	180	385	7	13
JI500 037G4/JI500 045F4	37/45	66.5/81.7	65/80									
JI500 045G4/JI500 055F4	45/55	81.7/101.9	80/100	500	520	300	275	283	220	500	10	41.2
JI500 055G4	55	101.9	100									

Remark: JI500 series frequency inverter JI500 132G3/JI500 160F3~JI500 400G3, "R" stands for "built-in DC choke", for example JI500 160G3R, JI500 160G4R. After installing the screw rings, the height dimensions is: H1+15mm.

## Standard specification









Item	Function	Specification
Power	Rated voltage level	AC 3PH 480V(-10%)~480V(+10%) AC 3PH 380V(-15%)~440V(+10%) AC 1PH 220V(-15%)~240V(+10%) AC 3PH 220V(-15%)~240V(+10%)
	Input frequency	50Hz/60Hz
	Allowable fluctuation	Voltage continued volatility $\pm 10\%$ input frequency volatility: $\pm 5\%$ Voltage unbalance rate less than 3%      Distortion meet IEC 61800-2 standard
Control System	Control system	High performance vector control inverter based on DSP
	Control method	V/F control, vector control W/O PG, vector control W/PG
	Automatic torque boost function	Realize low frequency (1Hz) and large output torque control under the V/F control mode.
	Acceleration/deceleration control	Straight or S-curve mode. Four times available and time range is 0.0 to 6500.0s.
	V/F curve mode	Linear, square root/m-th power, custom V/F curve
	Over load capability	G type: rated current 150% - 1 minute, rated current 180% - 2 seconds F type: rated current 120% - 1 minute, rated current 150% - 2 seconds
	Maximum frequency	Vector control: 0 to 300Hz V/F control: 0 to 3200Hz
	Carrier Frequency	0.5 to 16kHz; automatically adjust carrier frequency according to the load characteristics.
	Input frequency resolution	Digital setting: 0.01Hz Analog setting: maximum frequency $\times 0.1\%$
	Start torque	G type: 0.5Hz/150% (vector control W/O PG) F type: 0.5Hz/100% (vector control W/O PG)
	Speed range	1:100 (vector control W/O PG) 1:1000 (vector control W/ PG)
	Steady-speed precision	Vector control W/O PG: $\leq \pm 0.5\%$ (rated synchronous speed) Vector control W/ PG: $\leq \pm 0.02\%$ (rated synchronous speed)
	Torque response	$\leq 40\text{ms}$ (vector control W/O PG)
	Torque boost	Automatic torque boost; manual torque boost(0.1% to 30.0%)
	DC braking	DC braking frequency: 0.0Hz to max. frequency, braking time: 0.0 to 36.0 seconds, braking current value: 0.0~100.0s
Jogging control	Jog Frequency Range: 0.00Hz to max. frequency; Jog Ac/deceleration time: 0.0s~6500.0s	
Multi-speed operation	Achieve up to 16-speed operation through the control terminal	
Built-in PID	Easy to realize closed-loop control system for the process control.	
Automatic voltage regulation(AVR)	Automatically maintain a constant output voltage when the voltage of electricity grid changes	
Torque limit and control	"Excavator" feature - torque is automatically limited during the operation to prevent frequent overcurrent trip; the closed-loop vector mode is used to control torque.	
Personalization function	Self-inspection of peripherals after power-on	After powering on, peripheral equipment will perform safety testing, such as ground, short circuit, etc.
	Common DC bus function	Multiple inverters can use a common DC bus.
	Quick current limiting	The current limiting algorithm is used to reduce the inverter overcurrent probability, and improve whole unit anti-interference capability.
	Timing control	Timing control function: time setting range(0h to 6500m).



Item	Function	Specification	
Running	Input signal	Running method	Keyboard/terminal/communication
		Frequency setting	10 frequency setting available, including adjustable DC 0-10V / -10-+10V, adjustable DC 0-20mA, panel potentiometer
		Start signal	Rotate forward/reverse
		Multi-speed	At most 16-speed can be set(run by using the multi-function terminals or program)
		Emergency stop	Interrupt controller output
		Wobulate run	Process control run
		Fault reset	When the protection function is active, you can automatically or manually reset the fault condition.
	PID feedback signal	Including DC(0 to 10V), DC(0 to 20mA)	
	Output signal	Running status	Motor status display, stop, ac/deceleration, constant speed, program running status.
		Fault output	Contact capacity: normal-closed contact 3A/AC 250V; normal-opened contact 5A/AC 250V; 1A/DC 30V.
Analog output		Two-way analog output, 16 signals can be selected such as frequency,current,voltage and other, output signal range(0 to 10V /0 to 20mA).	
Output signal		At most 4-way output,there are 40 signals each way	
Run function	Limit frequency,jump frequency,frequency compensation,auto-tuning, PID control		
DC current braking	Built-in PID regulates braking current to ensure sufficient braking torque under no overcurrent condition.		
Running command channel	Three channels: operation panel,control terminals and serial communication port. They can be switchedthrough a variety of ways.		
Frequency source	Total 10 frequency sources: digital,analog voltage,analog current, multi-speed and serial port. They can be switched through a variety of ways.		
Input terminals	8 digital input terminals, compatible with active PNP or NPN input mode, one of them can be for high-speedpulse input(0-100Hz square wave); 3 analog output terminals,AI1 and AI2 can choose 0-10V or 0-20mA input, AI3 voltage is -10-+10V input.		
Output terminals	2 digital output terminals, one of them can be for high-speed pulse output(0 to 100kHz square wave); one relay output terminal; 2 analog output terminals respectively for optional range (0 to20mA or 0 to 10V),they can be used to set frequency, output frequency, speed and other physicalparameters.		
Protection function	Inverter protection	Overvoltage protection, undervoltage protection, overcurrent protection, overload protection, overheat protection, overcurrent stall protection, overvoltage stall protection, losing-phase protection (optional), external fault, communication error, PID feedback signal abnormalities, PG failure and short circuit to ground protection.	
	IGBT temperature display	Displays current temperature IGBT	
	Inverter fan control	Can be set	
	Instantaneous power-down restart	Less than 15 milliseconds: continuous operation. More than 15 milliseconds: automatic detection of motor speed, instantaneous power-down restart.	
	Speed start tracking method	The inverter automatically tracks motor speed after it starts	
	Parameter protection function	Protect inverter parameters by setting administrator Password and decoding	
Display	LED/OLED display keyboard	Running information	Monitoring objects including : running frequency, set frequency, actual motor current, DC bus voltage, output voltage, actual motor speed, cumulative running time, IGBT temperature, PID reference value, PID feedback value, input terminal status, output terminal status, analog AI1 value, analog AI2 value, current stage of multi-speed, torque set value.
		Error message	At most save 3 error message, and the time, type, voltage, current, frequency and work status can be queried when the failure is occurred.
	LED display	Display parameters	
	OLED display	Optional, prompts operation content in Chinese/English text.	
	Parameters copy	Can uploading or downloading the function code information of frequency inverters, do the parameter copy quickly.	
Key lock and function selection	Lock part or all of keys, define the function scope of some keys to prevent misuse.		
Communication	RS485	The optional completely isolated RS485 communication module can communicate with the host computer.	
Environment	Environment temperature	-10 ℃ to 40 ℃ (temperature at 40 ℃ to 50 ℃, please derating for use)	
	Storage temperature	-20 ℃ to 65 ℃	
	Environment humidity	Does not exceed 90% R.H, no condensation of moisture	
	Vibration	Below 5.9m/s <sup>2</sup> (= 0.6g)	
	Application sites	Indoor where no sunlight or corrosive, explosive gas and water vapor, dust, flammable gas, oil mist, water vapor, drip or salt, etc.	
	Altitude	Below 1000m	
	Pollution degree	2	
IP degree	IP20		
Product standard	Product adopts safety standards.	IEC61800-5-1:2007	
	Product adopts EMC standards.	IEC61800-3:2005	
	Cooling method	Forced air cooling	

## Operating keyboard (button key description)



Sign	Name	Function
	Parameter Setting/ Exit Key	*Enter top menu parameter change status *Exit from function option change *Return to status display menu from sub-menu or function option menu
	Shift Key	*Select circularly parameters under run or stop interface; *Select parameters when modifying the parameters.
	Ascending Key	*UP key setted by parameter F6.18
	Decending Key	*DOWN key setted by parameter F6.19
	Run Key	*Used for running operation in the keyboard mode.
	Stop/Reset Key	*For stopping running in the running status; for resetting the operation in fault alarm status. *The function of the key is subject to F6.00
	Enter Key	*Enter into levels of menu screen, confirm settings.
	Quick multifunction key	*This key function is determined by the function code F6.21.
	Keyboard encoder	*In query status: functional items increasing and decreasing *In modify status: function feagues or editing increasing or decreasing *In monitoring status: setting frequency increasing or decreasing

## Installation instruction

### Installation direction and Vacancy

The requirement concerning the minimum space around the inverter varies according to the power rating.

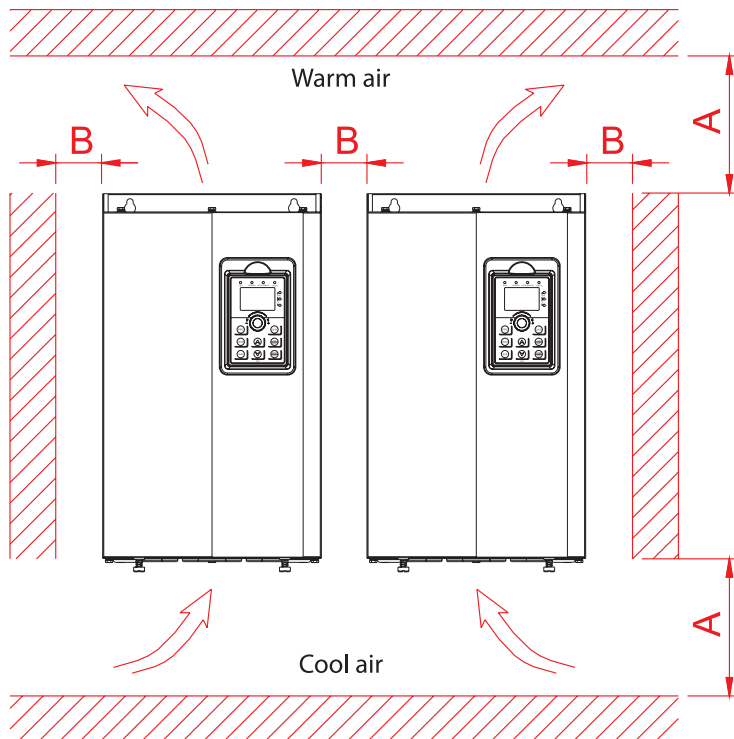

The JI500 Series frequency inverter radiates the heat from bottom to top. When more than one inverter work together, please mount side by side. In case of the need to install them by upper and lower rows, make sure the upper rows receive cool air. Heat insulation deflectors and other objects need to be installed to realize this.

Mounted vertically upwards	Dimension requirement
7.5 ~ 22KW	A ≥ 200mm; B ≥ 10mm
30 ~ 75KW	A ≥ 200mm; B ≥ 50mm
93 ~ 400KW	A ≥ 300mm; B ≥ 50mm

### Use of the environment

1. Environmental temperature -10°C to 50°C, Above 40°C, the capacity will decrease 3% by each 1°C. So it is not advisable to use inverter above 50°C.
2. Prevent electromagnetic interference, and away from interference sources.
3. Prevent the ingress of droplets, vapor, dust, dirt, lint and metal fine powder.
4. Prevent the ingress of oil, salt and corrosive gases.
5. Avoid vibration.
6. Avoid high temperature, humidity or exposure to rain. Humidity should not exceed 90% RH (non-condensing). In the presence of corrosive gas, maximum relative humidity should not exceed 60% RH.
7. Altitude should not exceed 1000 meters.
8. Never use in dangerous environments of flammable, combustible, explosive gasses, liquids or solids.

### Wiring

Frequency inverter wiring is divided by main circuit and control circuit. Users must properly connect the frequency inverter in accordance with the wiring connection diagram.

Some application cases



**Fan Industry**

- centrifugal compressor, axial-flow compressor, centrifugal blower, roots blower, centrifugal fan, axial flow fan, fan blower



**Coal Mining Industry**

- engine analyzer, slag pot carrier, feeding machine, iron ladle motor, fireproof door motor, ore washing pump, suction fan in the pit, air supply system, hauling machine



**Hoisting Industry**

- mine hoist, mining electric locomotive, port hoist, builders' lift, pile driver, large crane motor, tower crane, lifting



**Petroleum Industry**

- plunger pump, beam pumping unit, oil transfer pump, gas transmission pipeline system compressor,



**Chemical Industry**

- vacuum kneader (agitator), dryer, film blowing machine, plastic mill, pulverizer, drafting device for short fiber, high speed spinning machine for chemical fiber, feedstock pump for oil refinery, pump for coking unit



**Iron And Steel Industry**

- winding engine for iron-smelting blast furnace, dust removing blower for blast furnace, air blower for blast furnace gas blanketing, blowing engine, roots blower for digital thermometer, variable frequency exhaust fan for steel furnace roasting and purifying fan, hot rolling machine, cold tandem rolling mill, feeding system, mill exhauster, vibrating sieving machine, wire drawing machine, winding machine, blender mixer, drying machine, slime pump, draining pump, water supply pump, unbender, pipemaking machine, ladle crane motor



**Power Industry**

- boiler blower, induced draft fan, boiler feeding pump, circulating water pump, low pressure drain pump, condensate pump, cooling water pump, mortar pump, coal feeder.



**Textile Industry**

- spinning machine, fagoting machine, pounding machine, knitting machine, centrifugal dehydrator, spinning frame, aeration machine for print works, tentering and thermo-fixing machine, high temperature dyeing machine, decorating machine, bleaching machine, dyeing jiggers

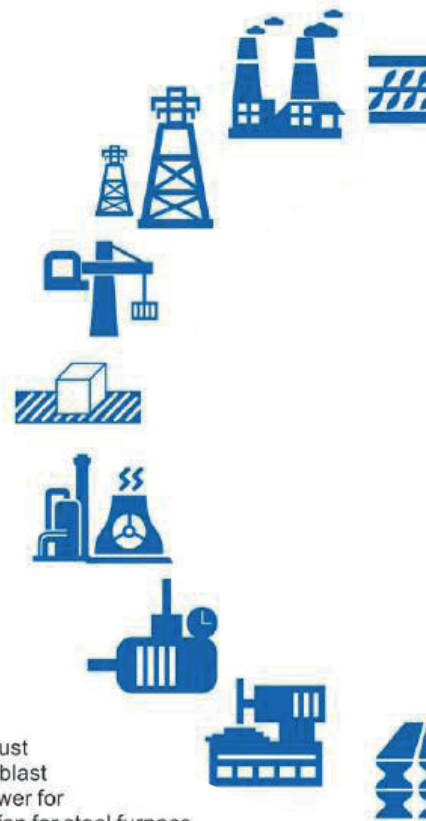

## Machine Tool Industry

- ncelectro-spindle, vertical lathe spindle, surface grinder spindle, boring machine spindle, sawing machine



## Injection Molding Machine

- extruding machine, injection machine, disc refiner, internal mixer, granulate machine

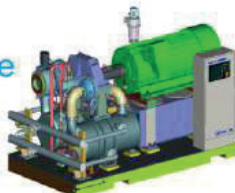

## Pump

- petroleum pump, metallurgical pump, chemical pump, fishing pump, mining pump, power pump, water conservancy pump, sewage pump, food pump, brewing pump, pharmacy pump, beverage pump, fuel pump, condiment pump, paper pump, textile pump, printing and dyeing pump, ceramic pump, paint conveyer pump, agricultural chemical pump, fertilizer pump, sugar-syrup pump, methanol pump, spary pump, salt pump, beer pump, starch pump, feed pump



## Winding Machine

- lithium battery winding machine, capacitor core winding machine, textile winding machine



## Conveyor Belt

- belt-type conveyer, plate conveyer, car type conveyer, escalator, passenger conveyer, scraper conveyer, embedded scraper conveyer, bucket conveyer, bucket elevator, underslung conveyer, underslung conveyer



## Heating System

- constant pressure water supply system for boiler, mill exhauster, belt conveyer for coal, coal breaker, air blower, induced draft fan, cold-rolling mill



## Compressor

- piston compressor, screw compressor, centrifugal compressor, linear compressor



## Photovoltaic

- microwave relay station, optical cable communication system, wireless paging station, satellite communication and satellite television receiving system, computerized telephone system in countryside, communication system in troops, railway and highway signalling system, lighthouse and beacon light, meteorological station, seismic station

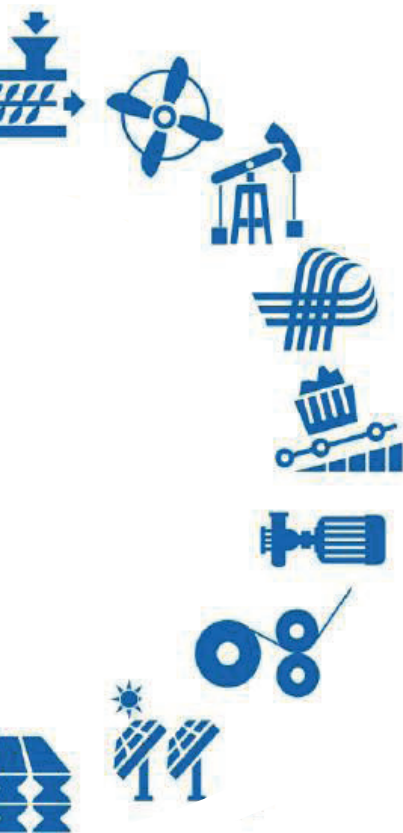

## Optional parts

Purpose	Name	Specification
Protect frequency inverter wiring	Wiring breaker or leakage protector	To protect frequency inverter connection, please set wiring breaker or leakage protector by the side of power supply. Please use preventing ultra-harmonics leakage protector.
Prevent braking resistor burning-out	AC contactor	To prevent braking resistor burning-out when connecting, please set AC contactor, meanwhile, please connect surge absorber on the coil.
Preventing switching surge leaking out	Surge absorber	Surge absorber absorbing electromagnetic contactor and control relay switching surge, please install surge absorber on the electromagnetic contactor and control relay of frequency inverter.
Insulation input/output signal	Isolator	Due to frequency inverter insulation input/output signal, isolator can reduce inductive interference effectively
Improve frequency inverter input power factor	DC reactor/AC reactor	Apply to improve frequency inverter input power factor, please set DC reactor or AC reactor, when using large capacity power supply (above 600kW)
Reduce noise disturbance	Input noise filter	Input wiring can reduce noise flow into frequency inverter input power supply system. Please install the filter close to frequency inverter.
	Output noise filter	From frequency inverter output wiring reduce noise, please install the filter close to frequency inverter.
Machine stop running on setting time	Braking resistor	Braking unit will consume machine regenerated energy, which will reduce decrease time
	Braking unit	Braking unit and braking resistor combined using on machine, this will reduce motor decrease time.
Control frequency inverter operation from outside	Operator (small plastic-made device)	Control frequency setting and operation/stop operation by analog quantity instructions from distance.
	Operator (standard nickel clad made)	Control frequency setting and operation/stop operation by analog quantity instructions from distance.
Ensure frequency inverter sudden power failure compensation	Sudden power failure/compensate unit	To control power supply sudden failure compensation.
Setting and monitoring frequency and voltage from outside	Frequency meter	Outside setting and monitoring frequency device.
	Frequency setting device	
	Frequency setting device knob	
Adjust frequency instruction input and frequency meter, ampere meter full scale	Output voltmeter	Outside setting output volt device is PWM frequency inverter specialized voltmeter.
	Frequency instruction using thyrector baseboard	Install and control circuit terminal, input frequency instruction.
	Frequency meter full scale adjust resistor	Adjust frequency meter and ampere meter full scale.

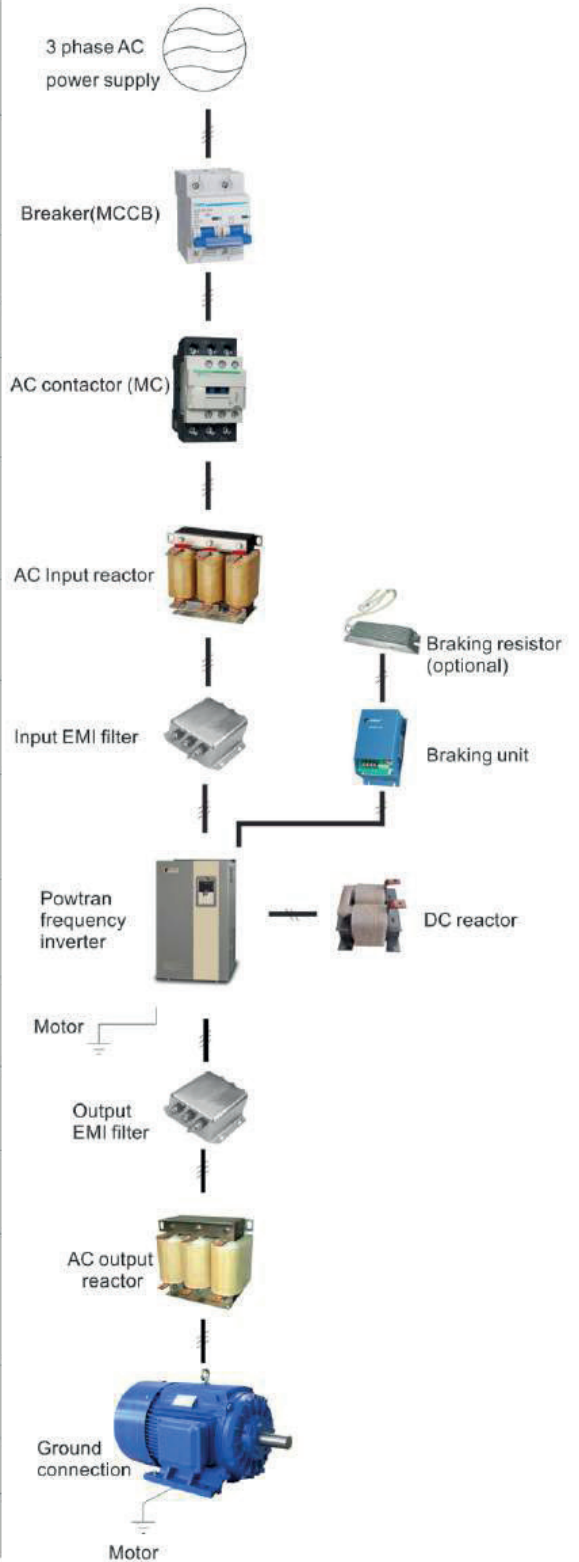

## GEAR MOTORS



## HEAVY DUTY GEAR BOXES

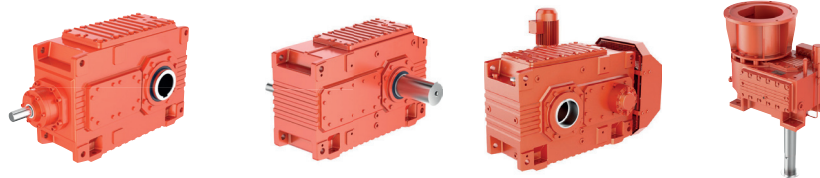

## PLANETARY GEAR BOXES



## CRES DRIVES



## WORM GEAR REDUCERS

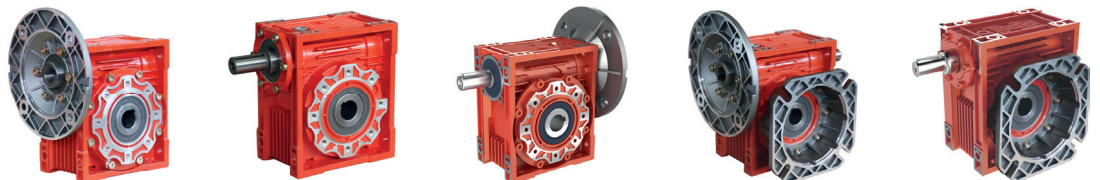

## ELECTRIC MOTORS

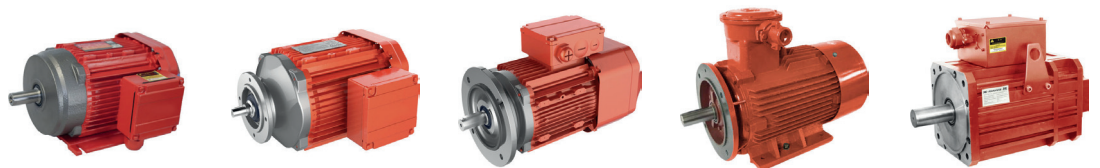

## VARIABLE-FREQUENCY DRIVE & ENCODERS



## SLEWING RINGS / DRIVES

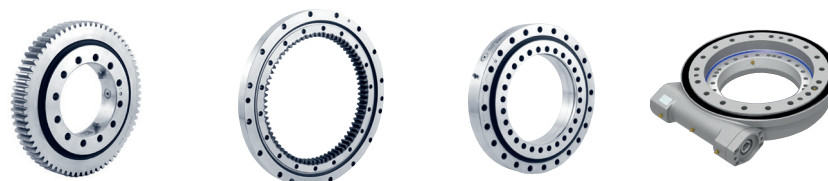



Hub van Doorneweg 8  
2171 KZ Sassenheim – NL

**T** +31(0)252 228850  
**F** +31(0)252 228235  
**E** info@euronorm.nl

***euronormdrives.com***